

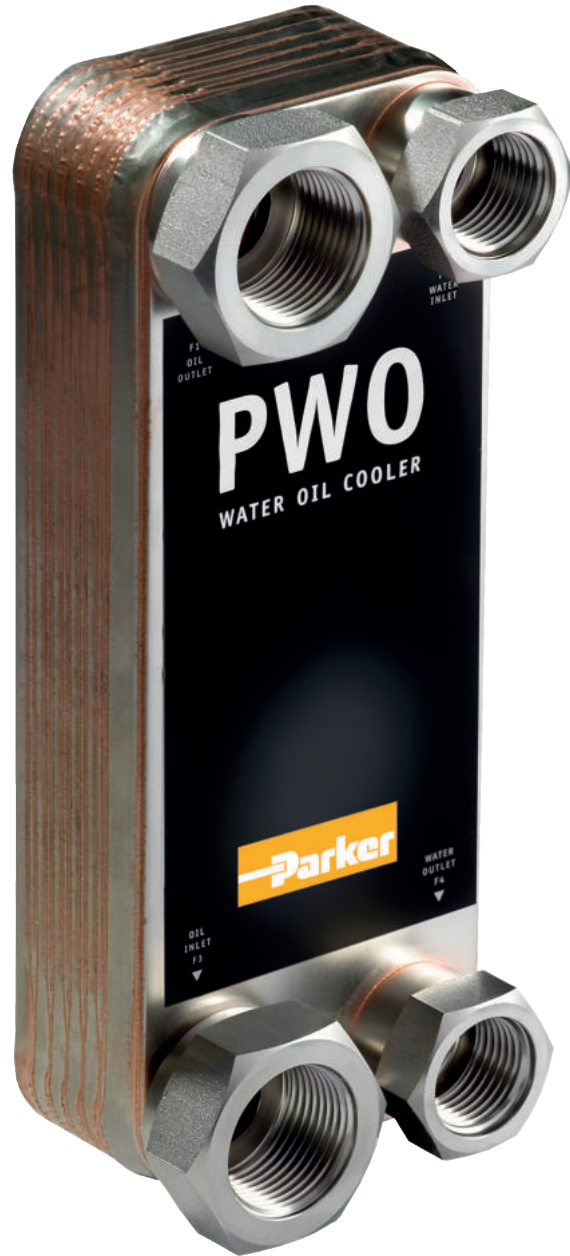

aerospace
climate control
electromechanical
filtration
fluid & gas handling
hydraulics
pneumatics
process control
sealing & shielding

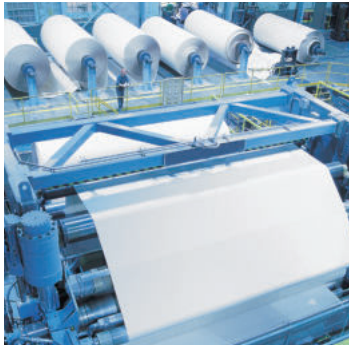

PWO Water/oil cooler

Lightweight, compact and efficient for industrial and marine applications



TRIDENT PRECISION INTERNATIONAL

151, SECTOR-06, IMT MANESAR, GURGAON, HARYANA

122050

 0124-4101151



WWW.TRIDENTPRECISION.IN



sales@tridentprecision.in

A unique design

Maintenance free optimal performance

The Parker PWO is a compact and lightweight water/oil cooler with a high cooling capacity for its size. The cooling elements consist of corrugated channel plates sandwiched between the front and rear cover plates. The channel plates are pressed and vacuum brazed in the same automated procedure, with rigorous standards of quality control.

The unique plate design provides a highly turbulent flow throughout the cooler, which is

the key to efficient cooling. This reduces the risk for clogging, which in turn makes the PWO virtually maintenance free.

Endless possibilities

The PWO's design emphasizes a number of possibilities for versatile and efficient solutions. It can easily be adapted to a variety of needs and special applications including seawater, aggressive oils, high pressure and high temperature applications. With a PWO water/oil cooler in your

system, you can be assured that the fluid in your system is working at the correct temperature, providing maximum performance and reliability.

PWO water/oil coolers in short:

- **Light and compact**
- **Suitable for many applications**
- **Easy installation**
- **Cost-efficient and environmentally friendly**

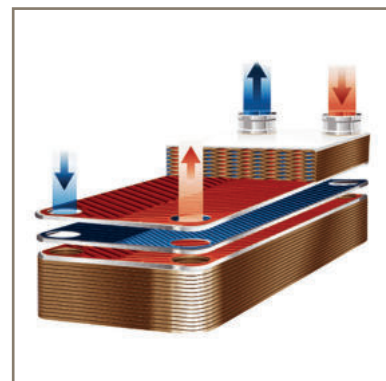

The Parker plate water/oil cooler has a unique plate design which provides a highly turbulent flow, which is the key to efficient cooling.

The Olaer Group has been part of Parker Hannifin since July 1st, 2012. With manufacturing and sales in 14 countries in North America, Asia and Europe, the Olaer Group expands Parker's presence in geographic growth areas and offers expertise in hydraulic accumulator and cooling systems for target growth markets such as oil and gas, power generation and renewable energy.

PWO – a complete cooling system

A plate water/oil cooler range to suit all needs

The PWO standard range of water oil coolers is available in a wide number of sizes and is in general available for immediate off-the-shelf delivery. The basic material is stainless steel (AISI 316/304), vacuum brazed with pure copper. AISI 316 can be limited to the parts of the PWO that actually come in contact with fluid, such as the channel plates. PWO only requires small hold up volumes which equals lower cost and a more environmentally-friendly solution. Low installation cost allows for oversizing for future requirements or peak loads.

PWO in Mo-steel provides higher resistance against pitting, crevice corrosion and chloride-rich fluids compared to AISI 316. The state-of-the-art brazing technology eliminates the risk of intergranular corrosion. Mo-steel can be limited to the parts of the PWO that actually come in contact with fluid, such as the channel plates. Typical applications for the Mo-series are in industrial conditions where high chloride concentrations put high demands on corrosion resistance. The pulp and paper industries also often use processes with chloride-rich fluids.

PWO in stainless steel is free from copper. The nickel-based brazing material has increased resistance to aggressive media and can endure higher working temperatures than a copper-brazed PWO. PWO in stainless steel is used where the water supply is corrosive to copper. Other applications are cooling or heating of oil with a high content of sulphur or ammonia-based cooling systems where

copper is prohibited, as well as pharmaceutical and chemical applications where copper-brazed coolers are susceptible to corrosion from acids and bases. Another field of application is in high-temperature applications, such as heating of oils.

PWO-M is an extremely small water/oil cooler, perfect wherever compactness is crucial. The gaskets and the plates can be made of various materials to ensure compatibility with the refrigerant. Even if a costlier, high performance metal is required for the heat transfer surfaces, the front and back plates can be made of more basic materials to reduce cost. The snap-in-place connections allow easy assembly and the use of different metals without risk of weld deterioration. The PWO-M with plates made of titanium resists corrosive seawater in onboard engine coolers and applications containing de-ionized water or aggressive fluids. *See separate brochure, which can be downloaded from www.parker.com.*

PWO with double walled channel plates are designed for applications where high thermal efficiency is a requirement and the risk of internal leakage must be minimized. It is primarily used in sanitary water appli-



cations, coolers for the chemical process industries, food and pharmaceutical industries.

PWO for high pressure is designed to meet the high demands in applications with working pressures up to 45 bar (*Note: special models and configurations are available for max working pressure 120 bar*). With the exception of high pressure applications such as within the process industry, the PWO is perfect for use with new, high-capacity, environmentally-friendly refrigerants. The PWO's greater heat transfer efficiency provides opportunities linked to energy-cost and environmental savings.



Oil type: ISO VG 46
 Oil/water flow ratio: 2/1

Inlet oil temperature 60°C at Δp max 2 bar
 Inlet water temperature 20°C

**Heat Load (kW)
 B5T**

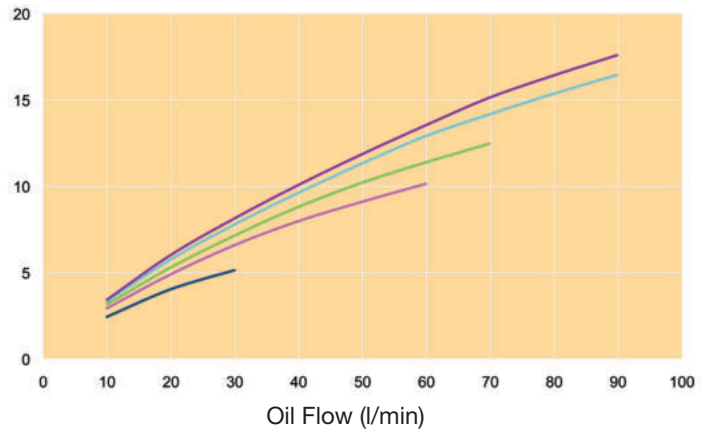
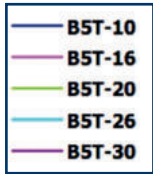

**Pressure Drop (bar)
 B5T**

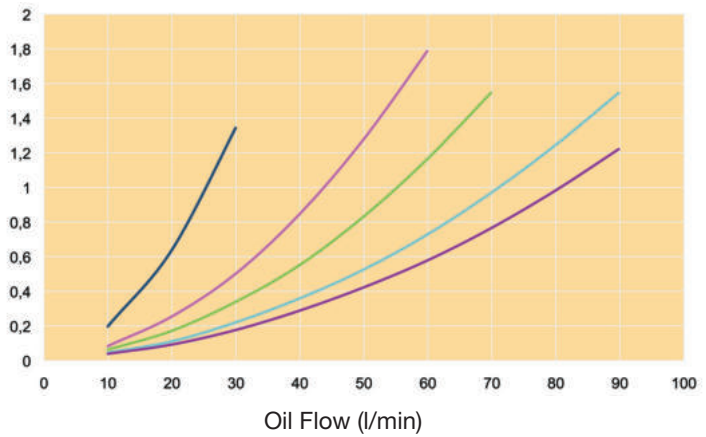
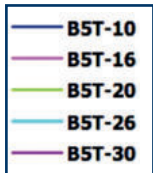

**Heat Load (kW)
 B8T**

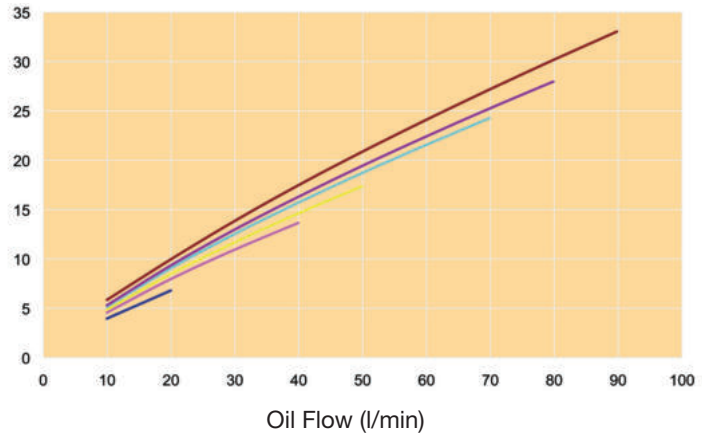
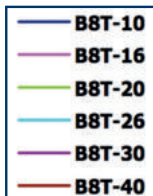

**Pressure Drop (bar)
 B8T**

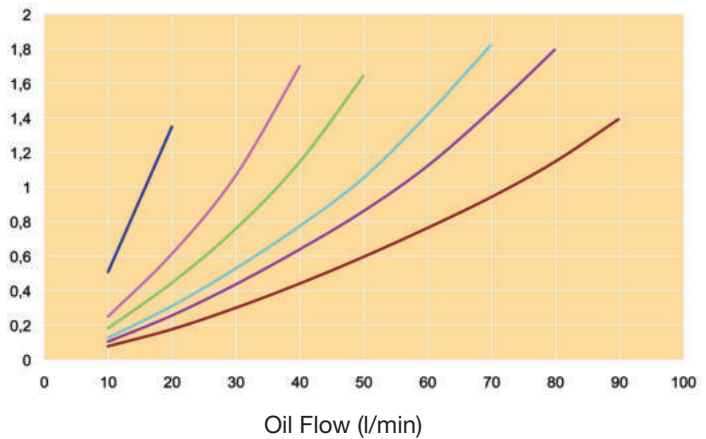
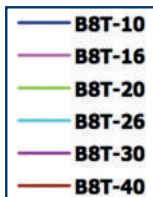

Oil type: ISO VG 46
 Oil/water flow ratio: 2/1

Inlet oil temperature 60°C at Δp max 2 bar
 Inlet water temperature 20°C

**Heat Load (kW)
 B15**

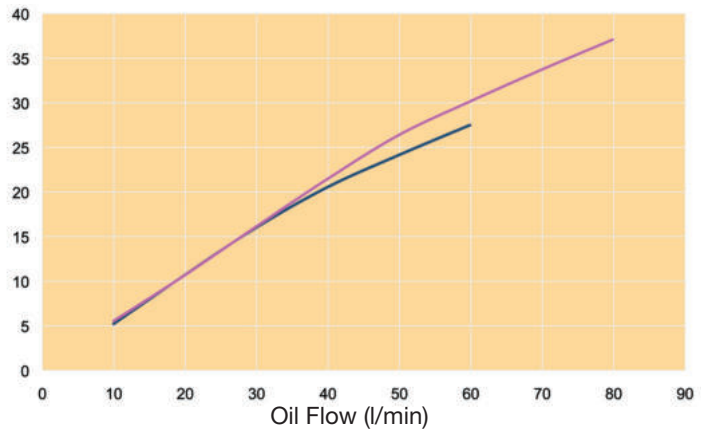
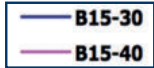

**Pressure Drop (bar)
 B15**

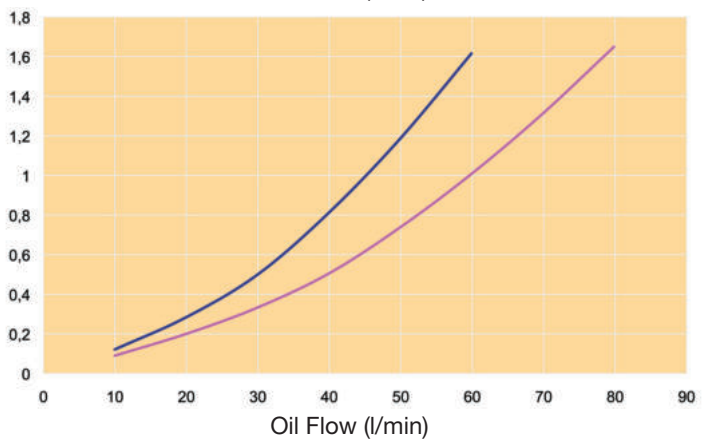

**Heat Load (kW)
 B10T**

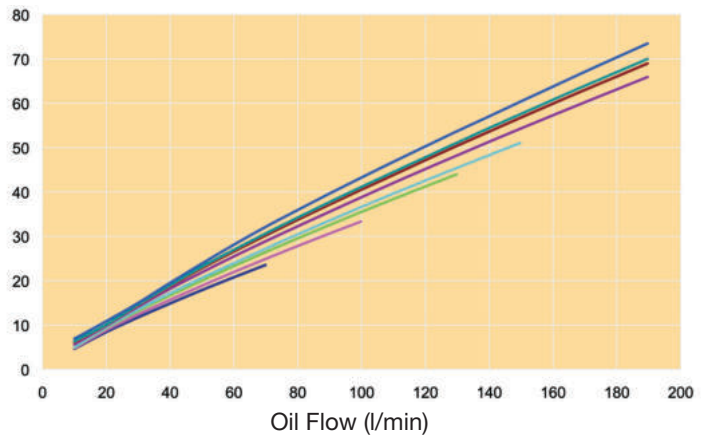
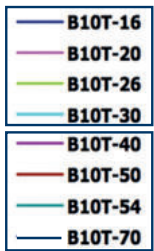

**Pressure Drop (bar)
 B10T**

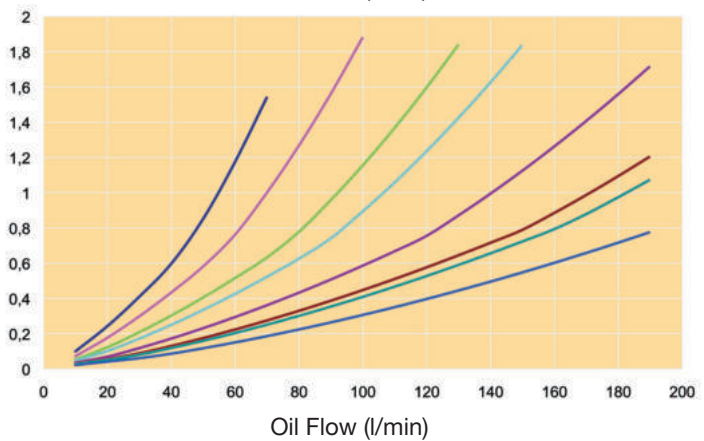
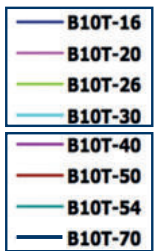

Oil type: ISO VG 46
 Oil/water flow ratio: 2/1

Inlet oil temperature 60°C at Δp max 2 bar
 Inlet water temperature 20°C

**Heat Load (kW)
 B25T**

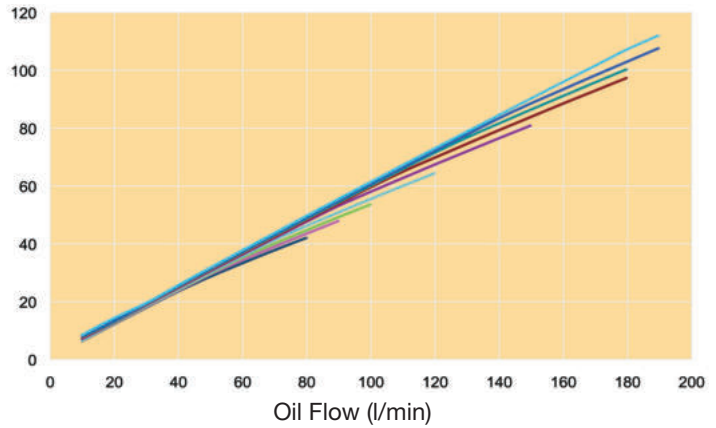
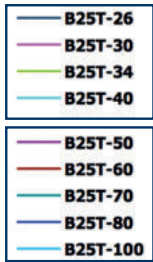

**Pressure Drop (bar)
 B25T**

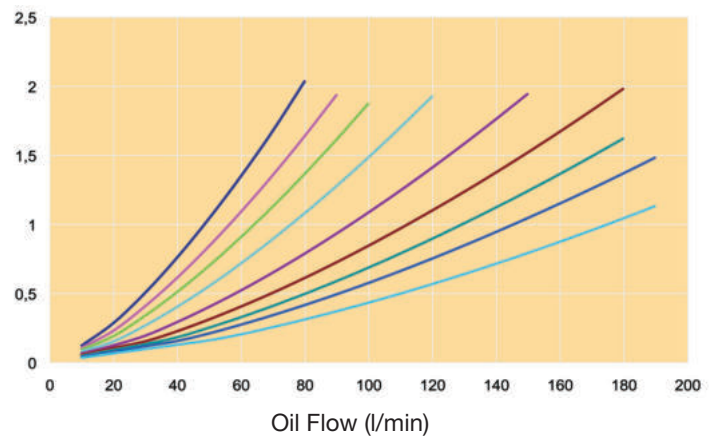
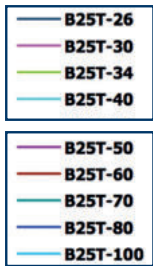

**Heat Load (kW)
 B12**

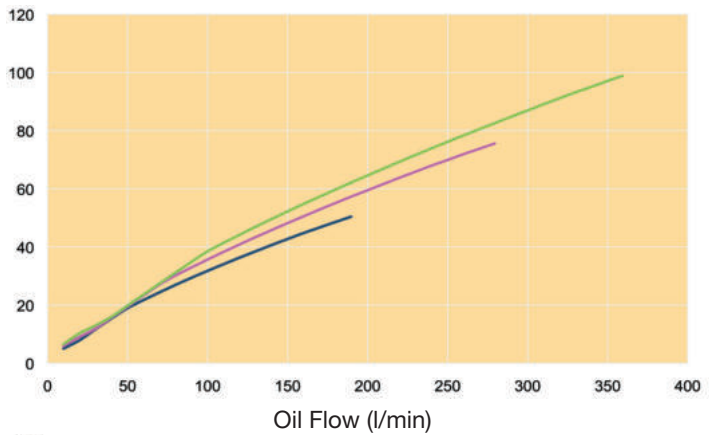

**Pressure Drop (bar)
 B12**

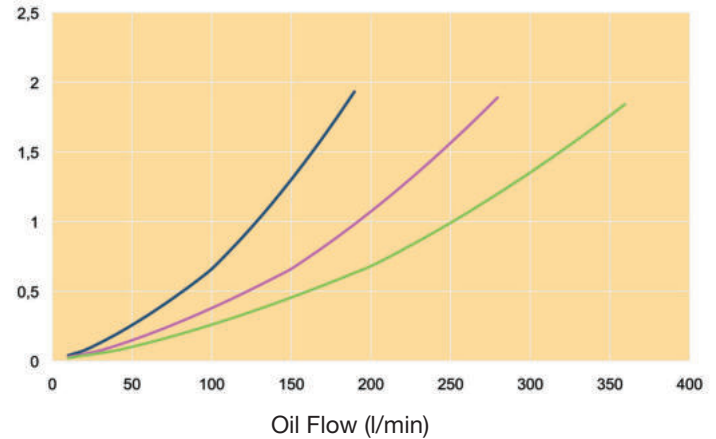

Oil type: ISO VG 46
 Oil/water flow ratio: 2/1

Inlet oil temperature 60°C at Δp max 2 bar
 Inlet water temperature 20°C

**Heat Load (kW)
 B16**

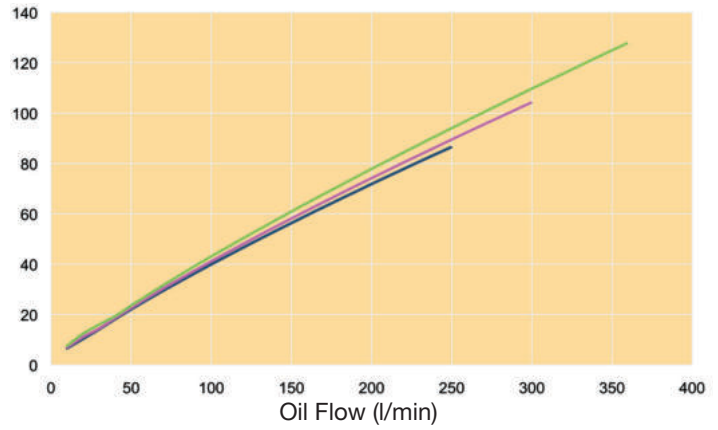
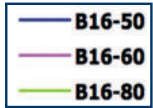

**Pressure Drop (bar)
 B16**

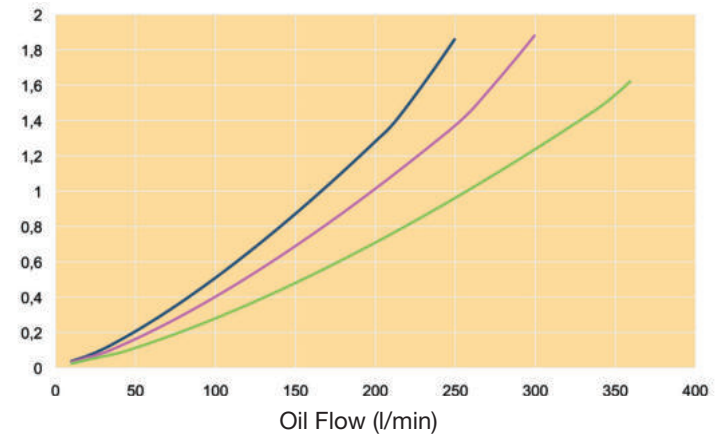
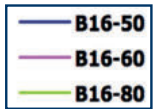

**Heat Load (kW)
 B28**

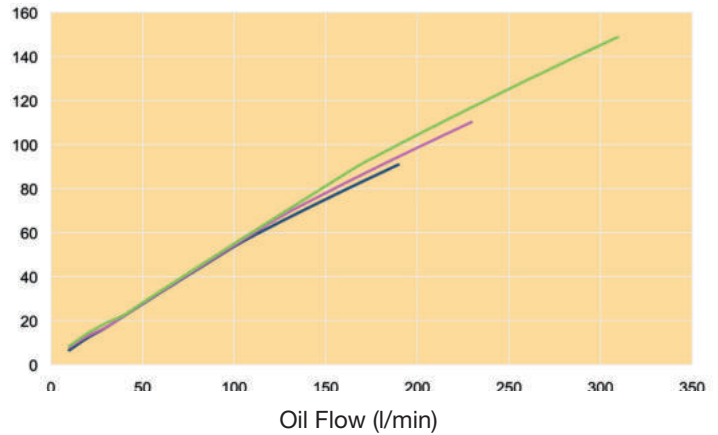
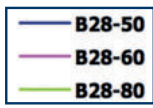

**Pressure Drop (bar)
 B28**

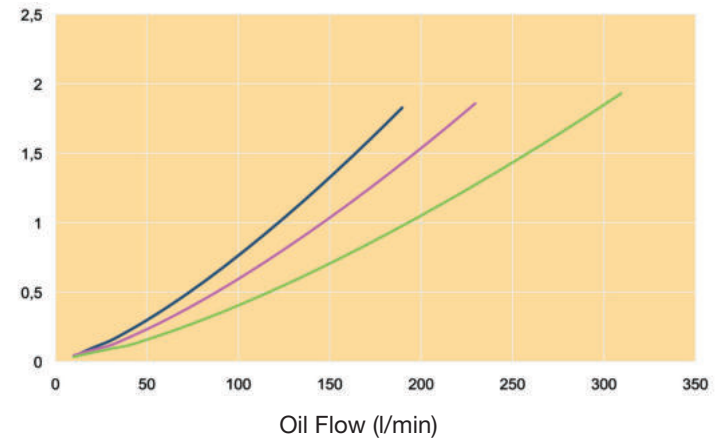
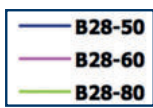

Oil type: ISO VG 46
 Oil/water flow ratio: 2/1

Inlet oil temperature 60°C at Δp max 2 bar
 Inlet water temperature 20°C

**Heat Load (kW)
 B35**

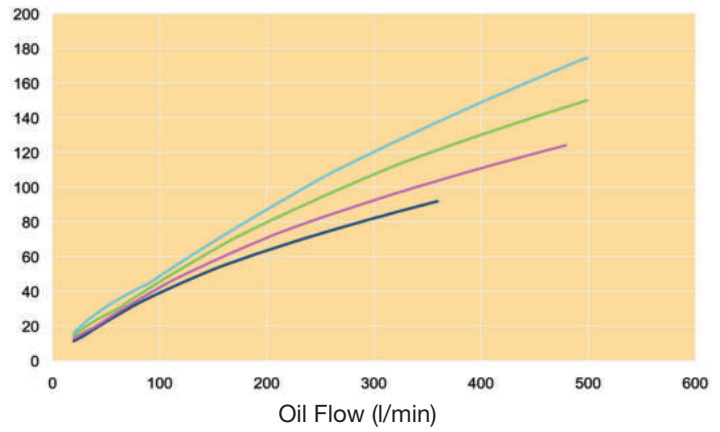

**Pressure Drop (bar)
 B35**

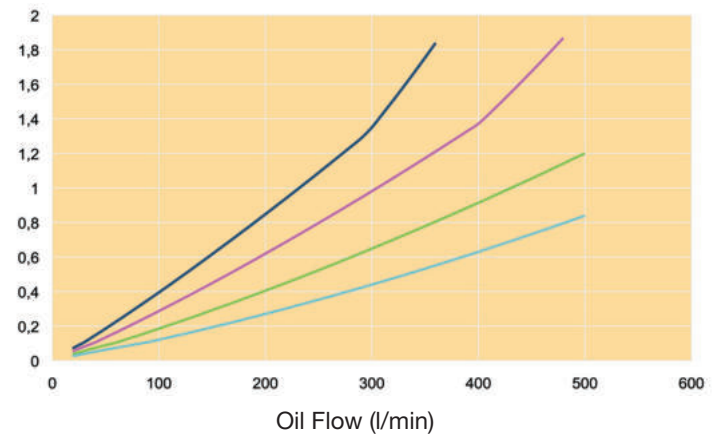
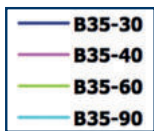

**Heat Load (kW)
 B120T**

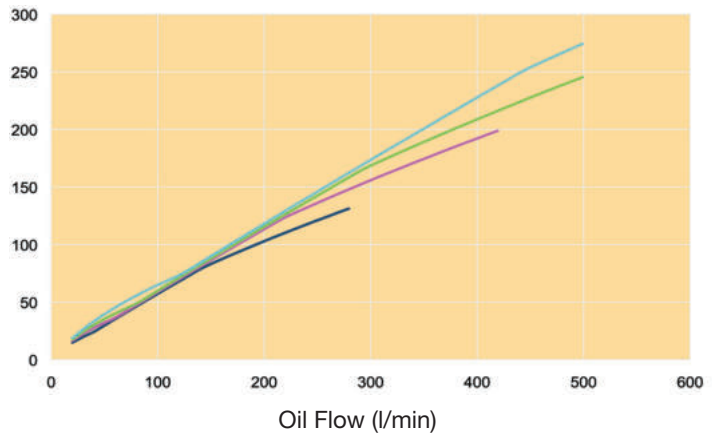
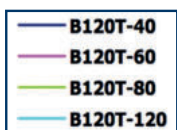

**Pressure Drop (bar)
 B120T**

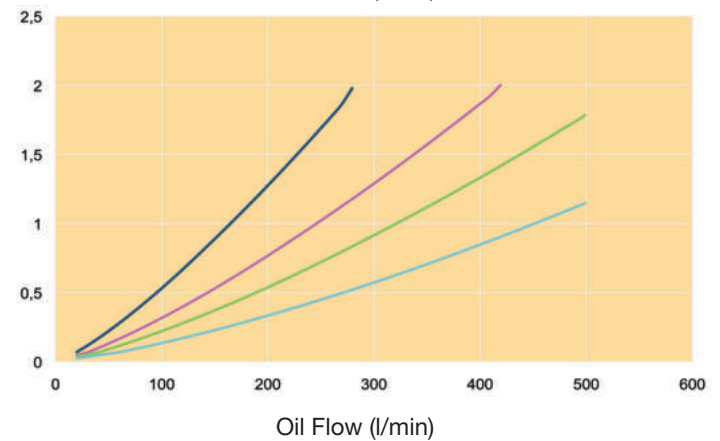
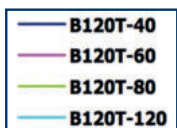

Oil type: ISO VG 46
 Oil/water flow ratio: 2/1

Inlet oil temperature 60°C at Δp max 2 bar
 Inlet water temperature 20°C

**Heat Load (kW)
 B56**

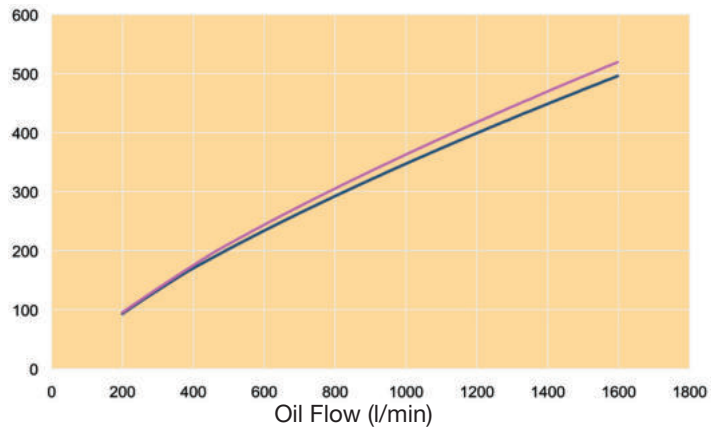
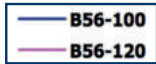

**Pressure Drop (bar)
 B56**

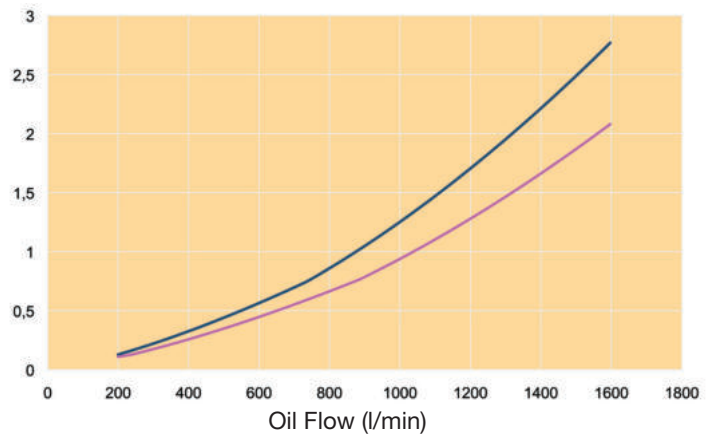

A lot more than excellent coolers

Together we review all conditions – the water/oil cooler performance, the working environment, the type of fluid to be cooled, etc. Because of our deep knowledge and long experience, we can build on previous solutions and discuss all feasible solutions. All information will be entered into the calculation software, which will quickly and accurately show the most adequate solution. It is a simple

and easily accessible aid, which based on given parameters will select the most adequate cooler with regard to function and economy. The software can be downloaded for free from www.parker.com/acde. Our technicians are also at your disposal if you have any inquiries about the software and its use.



PWO Standard Range of water oil coolers is available in a wide number of sizes and is in general available for immediate off-the-shelf delivery. The basic material is AISI 316 stainless steel, vacuum brazed with pure copper. The PWO requires only a small refrigerant volume resulting in lower cost and a more environmentally-friendly installation. Low installation cost allows for oversizing to accommodate for future increase in requirements or peak loads.

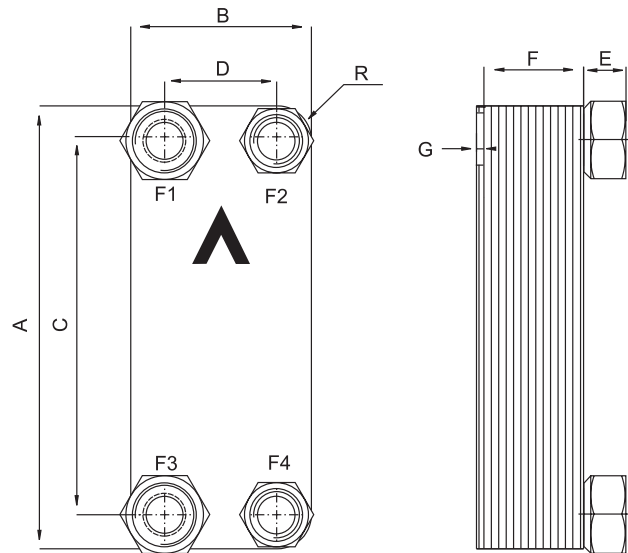

TYPE	A mm (±2)	B mm (±1)	C mm (±1)	D mm (±1)	E mm (±1) (+0.5% - 1.5%)	F * = x number of plates (±1)	G mm	R mm
B5T	193	76	154	40	20.1 2x3/4" - 2x1/2"	2.24 x * + 4	7	18
B8T	317	76	278	40	20.1 2x3/4" - 2x1/2"	2.24 x * + 4	7	18
B10T	289	119	243	72	20.1 2x1" - 2x3/4"	2.24 x * + 4	6	22
B12H	287	117	234	63	27.1 2x1 1/4" - 2x1"	2.24 x * + 4	6	22
B15	465	72	432	40	20.1 2x3/4" - 2x1/2"	2.24 x * + 4	7	16
B16	376	119	320	63	27.1 2x1 1/4" - 2x1 1/4"	2.24 x * + 4	6	23
B25T	526	119	479	72	20.1 2x1 1/4" - 2x1"	2.24 x * + 4	6	23
B28	526	119	470	63	27.1 2x1 1/4" - 2x1 1/4"	2.24 x * + 4	6	23
B35	393	243	324	174	27.1 2x1 1/2" - 2x1 1/4"	2.34 x * + 8	3	35
B56	525	243	430	148	54.2 ISO G 4x 2 1/2"	2.44 x * + 14	3	48
B120T	525	243	456	174	27.1 2x1 1/2" - 2x1 1/4"	2.29 x * + 10	4	35

Units size >B35-90 should always be fixed with two clamps per cooler >B35-90

Clamp Part Number	A	B
PWOCLAMPB5	219	90
PWOCLAMPB8	346	90
PWOCLAMPB10B12	319	135
PWOCLAMPB15	496	90
PWOCLAMPB16B26	408	135
PWOCLAMPB25B28	554	135
PWOCLAMPB35	422	259
PWOCLAMPB50B120	554	259

Vibration damper A30x15 M8x20 is available separately with Parker Part Number 214025

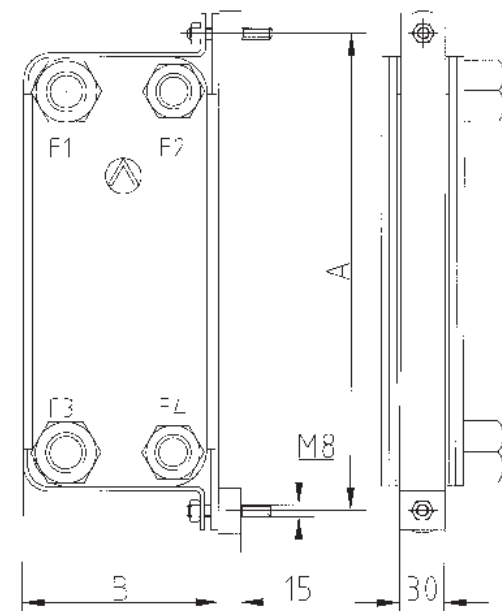



B5T
Dimensions
76 x 193 mm



B8T
Dimensions
76 x 317 mm



B10T
Dimensions
119x 289 mm



B12H
Dimensions
117 x 287 mm



B15
Dimensions
72 x 465 mm



B16
Dimensions
119 x 376 mm



B25T
Dimensions
119 x 526 mm



B28
Dimensions
119 x 526 mm



B35
Dimensions
243 x 393 mm



B56
Dimensions
243 x 525 mm



B120T
Dimensions
243 x 525 mm

TYPE	Max Temp °C	Min Temp °C	Working Pressure 155 °C bar	Test Pressure bar	Empty Weight kg * = number of plates
B5T	225	-196	31	50	0.50 + NoP* x 0.05
B8T	225	-196	31	50	0.81 + NoP* x 0.08
B10T	225	-196	31	50	1.39 + NoP* x 0.10
B12H	225	-196	28	45	1.44 + NoP* x 0.12
B15	225	-196	31	50	1.31 + NoP* x 0.10
B16	225	-196	31	50	1.73 + NoP* x 0.12
B25T	225	-196	31	50	2.15 + NoP* x 0.18
B28	225	-196	28	45	2.26 + NoP* x 0.16
B35	225	-196	31	50	6.99 + NoP* x 0.34
B56	225	-196	28	45	16.27 + NoP* x 0.42
B120T	225	-196	31	50	10.27 + NoP* x 0.40

Material:

Plates: EN 10028/7-1.4401 (AISI 316)

Brazing: Pure copper

Connections: EN 10272-1.4401 (AISI 316)



Parker Worldwide

Europe, Middle East, Africa

AE – United Arab Emirates, Dubai

Tel: +971 4 8127100
parker.me@parker.com

AT – Austria, Wiener Neustadt

Tel: +43 (0)2622 23501-0
parker.austria@parker.com

AT – Eastern Europe, Wiener Neustadt

Tel: +43 (0)2622 23501 900
parker.easteurope@parker.com

AZ – Azerbaijan, Baku

Tel: +994 50 2233 458
parker.azerbaijan@parker.com

BE/LU – Belgium, Nivelles

Tel: +32 (0)67 280 900
parker.belgium@parker.com

BG – Bulgaria, Sofia

Tel: +359 2 980 1344
parker.bulgaria@parker.com

BY – Belarus, Minsk

Tel: +48 (0)22 573 24 00
parker.poland@parker.com

CH – Switzerland, Etoy

Tel: +41 (0)21 821 87 00
parker.switzerland@parker.com

CZ – Czech Republic, Klecany

Tel: +420 284 083 111
parker.czechrepublic@parker.com

DE – Germany, Kaarst

Tel: +49 (0)2131 4016 0
parker.germany@parker.com

DK – Denmark, Ballerup

Tel: +45 43 56 04 00
parker.denmark@parker.com

ES – Spain, Madrid

Tel: +34 902 330 001
parker.spain@parker.com

FI – Finland, Vantaa

Tel: +358 (0)20 753 2500
parker.finland@parker.com

FR – France, Contamine s/Arve

Tel: +33 (0)4 50 25 80 25
parker.france@parker.com

GR – Greece, Athens

Tel: +30 210 933 6450
parker.greece@parker.com

HU – Hungary, Budaörs

Tel: +36 23 885 470
parker.hungary@parker.com

IE – Ireland, Dublin

Tel: +353 (0)1 466 6370
parker.ireland@parker.com

IL – Israel

Tel: +39 02 45 19 21
parker.israel@parker.com

IT – Italy, Corsico (MI)

Tel: +39 02 45 19 21
parker.italy@parker.com

KZ – Kazakhstan, Almaty

Tel: +7 7273 561 000
parker.easteurope@parker.com

NL – The Netherlands, Oldenzaal

Tel: +31 (0)541 585 000
parker.nl@parker.com

NO – Norway, Asker

Tel: +47 66 75 34 00
parker.norway@parker.com

PL – Poland, Warsaw

Tel: +48 (0)22 573 24 00
parker.poland@parker.com

PT – Portugal

Tel: +351 22 999 7360
parker.portugal@parker.com

RO – Romania, Bucharest

Tel: +40 21 252 1382
parker.romania@parker.com

RU – Russia, Moscow

Tel: +7 495 645-2156
parker.russia@parker.com

SE – Sweden, Spånga

Tel: +46 (0)8 59 79 50 00
parker.sweden@parker.com

SK – Slovakia, Banská Bystrica

Tel: +421 484 162 252
parker.slovakia@parker.com

SL – Slovenia, Novo Mesto

Tel: +386 7 337 6650
parker.slovenia@parker.com

TR – Turkey, Istanbul

Tel: +90 216 4997081
parker.turkey@parker.com

UA – Ukraine, Kiev

Tel: +48 (0)22 573 24 00
parker.poland@parker.com

UK – United Kingdom, Warwick

Tel: +44 (0)1926 317 878
parker.uk@parker.com

ZA – South Africa, Kempton Park

Tel: +27 (0)11 961 0700
parker.southafrica@parker.com

North America

CA – Canada, Milton, Ontario

Tel: +1 905 693 3000

US – USA, Cleveland

Tel: +1 216 896 3000

Asia Pacific

AU – Australia, Castle Hill

Tel: +61 (0)2-9634 7777

CN – China, Shanghai

Tel: +86 21 2899 5000

HK – Hong Kong

Tel: +852 2428 8008

IN – India, Mumbai

Tel: +91 22 6513 7081-85

JP – Japan, Tokyo

Tel: +81 (0)3 6408 3901

KR – South Korea, Seoul

Tel: +82 2 559 0400

MY – Malaysia, Shah Alam

Tel: +60 3 7849 0800

NZ – New Zealand, Mt Wellington

Tel: +64 9 574 1744

SG – Singapore

Tel: +65 6887 6300

TH – Thailand, Bangkok

Tel: +662 186 7000

TW – Taiwan, Taipei

Tel: +886 2 2298 8987

South America

AR – Argentina, Buenos Aires

Tel: +54 3327 44 4129

BR – Brazil, Sao Jose dos Campos

Tel: +55 800 727 5374

CL – Chile, Santiago

Tel: +56 2 623 1216

MX – Mexico, Toluca

Tel: +52 72 2275 4200



TRIDENT PRECISION INTERNATIONAL

151, SECTOR-06, IMT MANESAR, GURGAON, HARYANA

122050

0124-4101151



WWW.TRIDENTPRECISION.IN



sales@tridentprecision.in